

Connectors and Accessories Selection Guide

D38999 Series III

For Military, Aerospace & Harsh Environments.



WE'RE MATING TECHNOLOGY WITH CONFIDENCE



www.matec.com.tr

Table of Content

- 01** - Table of Content
- 02** - About Our Company
- 03** - How We Serve
- 04** - Inventory Solutions
- 05** - MIL-DTL-D38999 Series III
- 06** - MIL-DTL-38999 Series III, How to Order Military Designation
- 07** - MIL-DTL-38999 Series III, How to Order Amphenol Designation
- 08** - Square Flange Receptacle & Jam-Nut Receptacle
- 09** - Straight Plug
- 10** - Straight Boot: B1 Style & 90 Degree Boot: B2 Style
- 11** - Insert Arrangement Front Face of Pin Inserts Shown
- 12** - Insert Arrangement Front Face of Pin Inserts Shown
- 13** - Insert Arrangement Front Face of Pin Inserts Shown
- 14** - Insert Arrangement Front Face of Pin Inserts Shown
- 15** - Insert Arrangement Front Face of Pin Inserts Shown
- 16** - BK4S Backshell Drawing
- 18** - Other Backshell Types

About MATEC

MATEC Electronics is an authorized and leading distributor, that specializes on the design and custom-engineered connectors, cables and electronic interconnect solutions for Military-Aerospace, Industrial and Telecom market fields. MATEC's deep technical and commercial knowledge on it's concentrated product portfolio has made the company the chosen distributor of the customers in the region it serves, Turkey, Middle East, Africa and Eastern Europe. Headquartered in Istanbul, MATEC also has a branch office in Ankara and warehouses in Istanbul and NY, U.S.A. With it's highly experienced team, knowledge on dynamic supply chain solutions and rich inventory, MATEC has provided it's customer with the best technical and commercial service along with the quality products since it was founded in 2011. Our first priority is complete customer satisfaction. While MATEC's IPC/WHMA-A-620 certified technical team acts as design partner in your projects, the company commercial team ensures that the service given has it is highest achievable standards. Due to the fact that MATEC Electronics works with the world's well-known companies, it offers its products with proven quality to its customers. We are ISO 9001:2015 registered and dedicated to use those guidelines for your satisfaction.

Contact Us

Head Office

Ahi Evran Cad. N: 21
Kat: 4 Daire: 24
Polaris Plaza Maslak,
Sariyer, ISTANBUL

Phone: +90 212 346 16 06

Branch Office

Bestepe Mah. Nergis Sok.
Via Flat
Kat: 3 No: 7/2
Sogutozu, ANKARA

Warehouse

Tatlisu Mah.
Ersoy Sok.
No: 3
Umraniye, ISTANBUL

Phone: +90 216 365 80 10
Fax: +90 216 365 80 10



www.matec.com.tr

info@matec.com.tr



How We Serve

As a leading and authorized distributor, MATEC Electronics supports all types electrical interconnect requirements of Mil-Aero projects. MATEC is not only able to provide solutions to electronic interconnect requirements technically, but it also provides best commercial experience to it's customers with dynamic team.

5015 Series Connectors



Backshells



26382 Series Connectors

Inventory Solutions

In addition to commercial and customized harsh environment Mil-Aero series, MATEC also offers most popular qualified Mil-Spec versions for all type of your projects from it's inventory. MATEC also supports all type of connector accessory requirements like strain reliefs, backshells, heat shrink tubes and contacts, providing order-to-manufacture kit solutions.

D38999 Series Connectors



Boots



2M Series Connectors

MIL-DTL-D38999 Series III

Amphenol® Tri-Start MIL-DTL-38999 Series III Connectors offer the highest performance capabilities for both general duty and severe environment applications. Meeting or exceeding MIL- DTL-38999 Series III requirements, the Tri-Start connector with standard metal shells (aluminum or stainless steel with several finish options) offers these features:

Temperature: -65°C / + 200°C

EMI Shielding: EMI shielding capability of 65dB minimum at 10 GH

Moisture Resistance: Improved interfacial Seal

Quick Coupling: Completely mates and self-locks in a 360° turn of the coupling nut

Corrosion Resistance: Shells of stainless steel or cadmium over nickel plating withstand a 500 hour salt spray exposure

Mating Cycle: 500 couplings minimum

Contact Size	Test Current (Amps)		Maximum Millivolt	Maximum Millivolt
	Crimp	Hermetic	Drop Crimp*	Drop Hermetic*
23	5	3	73	85
22M	3	2	45	60
22D	5	3	73	85
22	5	3	73	85
20	7.5	5	55	60
16	13	10	49	85
12	23	17	42	85
10 (Power)	33	NA	33	NA
8 (Power)	46	NA	26	NA
4	80	NA	23	NA
0	150	NA	21	NA

Service Rating	Suggested Oper. Voltage (Sea Level)		Test Voltage (Sea Level)	Test Voltage (50,000 Ft.)	Test Voltage (70,000 Ft.)	Test Voltage (110,000 Ft.)
	AC (RMS)	DC				
M	400	500	1300 VRMS	550 VRMS	350 VRMS	200 VRMS
N	300	450	1000 VRMS	400 VRMS	260 VRMS	200 VRMS
I	600	850	1800 VRMS	600 VRMS	400 VRMS	200 VRMS
II	900	1250	2300 VRMS	800 VRMS	500 VRMS	200 VRMS

Applications: Military / Aerospace



MIL-DTL-D38999 Series III

How to Order

MILITARY DESIGNATION

D38999/ 26 W B35 P N - BK4S - B1

Series: _____

Shell Type: _____

20: Square Flange Receptacle 24: Jam-Nut Receptacle
26: Straight Plug

Shell Material and Finish: _____

Composite:
J: Olive drab cadmium plated 175°C M: Electroless nickel plated 200°C

Aluminium:
W: Olive drab cadmium plated 175°C
F: Electroless nickel plated 200°C
T: Nickel PTFE plated 175°C
Z: Black Zinc Nickel plated aluminium 175°C

Stainless Steel:
K: Passivated 200°C, firewall capability
S: Nickel plated 200°C, firewall capability

Shell Size and Contact Arrangement: _____

Shell Size:

A B C D E F G H J MIL
09 11 13 15 17 19 21 23 25 Amphenol

Contact Arrangement:

See section "Insert Arrangements"

Contact Type: _____

A: Without pin contact
B: Without socket contact
P: With pin contacts
S: With socket contacts

Polarization: _____

N for normal or A, B, C, D, E.

Backshell Type: _____

BK4S: Straight Direct Coupling EMI Backshell with Contact Force Spring and Conductive Tape
*Omit for no backshell

Boot Type: _____

B1: Straight Boot
B2: 90 Degree Boot
*Omit for no boot

MIL-DTL-D38999 Series III

How to Order

TV 06 R W 11-35 P A BK4S B2

AMPHENOL DESIGNATION

Series: _____

Shell Type: _____

- P00: Square flange receptacle: 175°C (O .D . cadmium, g .zinc cobalt, ni-PTFE, b .zinc nickel)
- PS00: Square flange receptacle: 200°C *** (nickel, s .steel, bronze)
- 07: Jam nut receptacle: 175°C (O .D . cadmium, g .zinc cobalt, ni-PTFE, b .zinc nickel)
- S07: Jam nut receptacle: 200°C *** (nickel, s .steel, bronze)
- 06: Straight plug: 175°C (O .D . cadmium, g .zinc cobalt, ni-PTFE, b .zinc nickel)
- S06: Straight plug: 200°C *** (nickel, s .steel, bronze)
- 01: In line receptacle 175°C (O .D . cadmium, g .zinc cobalt, ni-PTFE, b .zinc nickel)
- S01: In line receptacles 200°C *** (nickel, s .steel, bronze)

Contact Type: _____

- R: Crimp contacts (or connector delivered without contact)
- *For pc tail contacts directly get in touch with MATEC Electronics

Class: _____

- W: Olive Drab Cadmium plating (on aluminium or composite)
- F: Nickel Plating (on aluminium or composite)
- K: Passivated Stainless Steel
- S: Nickel plated Stainless Steel
- B: Marine Bronze (copper aluminium alloy)
- Z: Green zinc Cobalt plated aluminium
- ZN: Black Zinc Nickel plated aluminium

Shell Size and Contact Arrangement: _____

*** See section "Insert Arrangements"

Contact type: _____

- A: Without pin contact
- B: Without socket contact
- P: With pin contacts
- S: With socket contacts

Polarization: _____

N for normal or A, B, C, D, E.

Backshell Type: _____

- BK4S: Straight Direct Coupling EMI Backshell with Contact Force Spring and Conductive Tape
- *Omit for no backshell

Boot Type: _____

- B1: Straight Boot
- B2: 90 Degree Boot
- *Omit for no boot

MIL-DTL-D38999 Series III

Square Flange Receptacle

MIL DESIGNATION: D38999/20

AMPHENOL DESIGNATION: TVP00, TVS00

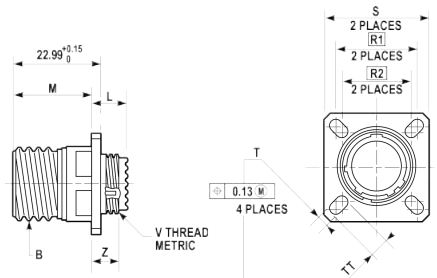

Shell Size		B Thread Class	L Max	M	R1 (mm)	R2 (mm)	S ±0.25	T	Z1 Max	TT	V Thread Metric
MIL-DTL-38999 Series III	Amphenol	2A 0.1P - 0.3L-TS (Inches)	(mm)	+0.00 -0.13 (mm)			(mm)	+0.25 -0.13 (mm)	(mm)	+0.20 -0.13 (mm)	
A	9	.6250	11.91	20.83	18.25	15.09	23.83	3.25	3.89	5.49	M12x1-6g
B	11	.7500	11.91	20.83	20.62	18.26	26.19	3.25	3.89	4.93	M15x1-6g
C	13	.8750	11.91	20.83	23.01	20.62	28.58	3.25	3.89	4.93	M18x1-6g
D	15	1.0000	11.91	20.83	24.61	23.01	30.96	3.25	3.89	4.39	M22x1-6g
E	17	1.1875	11.91	20.83	26.97	24.61	33.32	3.25	3.89	4.93	M25x1-6g
F	19	1.2500	11.91	20.83	29.36	26.97	36.53	3.25	3.89	4.93	M28x1-6g
G	21	1.3750	12.70	20.07	31.75	29.36	39.67	3.25	4.65	4.93	M31x-1-6g
H	23	1.5000	12.70	20.07	34.93	31.75	41.75	3.91	4.65	6.15	M34x1-6g
J	25	1.6250	12.70	20.07	38.10	34.93	44.93	3.91	4.65	6.15	M37x1-6g

MIL-DTL-D38999 Series III

Jam-Nut Receptacle

MIL DESIGNATION: D38999/24

AMPHENOL DESIGNATION: TV07, TVS07

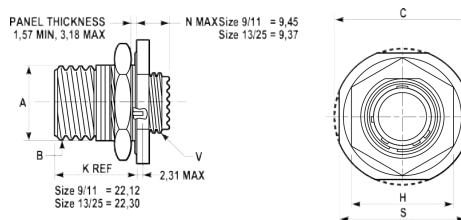

Shell Size		B Thread Class	A	C	H Hex	S +/-	V Thread	Hex Nut
MIL-DTL-38999 Series III	Amphenol	2A 0.1P - 0.3L-TS (Inches)	+0.10 0.15 (mm)	Max (mm)	+0.43 -0.41 (mm)	0.4 (mm)	Metric	Max Torque N.m
A	9	.6250	16.53	30.45	22.23	26.97	M12x1-6g	4.1
B	11	.7500	19.07	35.20	25.40	31.75	M15x1-6g	5.3
C	13	.8750	23.82	38.38	30.17	34.9	M18x1-6g	6.9
D	15	1.0000	26.97	41.55	33.32	38.10	M22x1-6g	8.6
E	17	1.1875	30.15	44.73	36.52	41.28	M25x1-6g	9.8
F	19	1.2500	33.32	49.50	39.67	46.0	M28x1-6g	10.9
G	21	1.3750	36.50	52.65	42.87	49.2	M31x1-6g	12.7
H	23	1.5000	39.67	55.85	46.02	52.37	M34x1-6g	13.8
J	25	1.6250	42.85	59.00	50.80	55.5	M37x1-6g	15

MIL-DTL-D38999 Series III

Straight Plug

MIL DESIGNATION: D38999/26

AMPHENOL DESIGNATION: TV06 TVS06

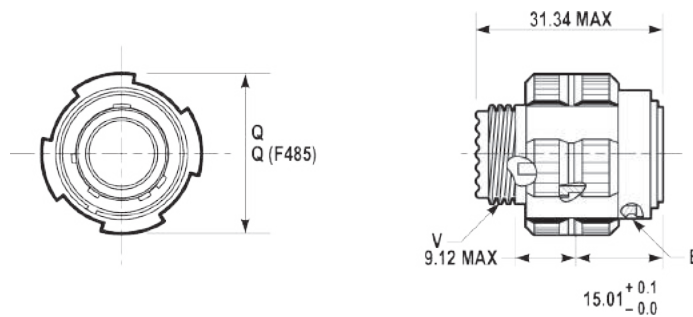

Shell Size		B Thread Class 2A 0.1P - 0.3L- TS	Q Max (mm)	V Thread Metric
MIL-DTL-38999 Series III	Amphenol			
A	9	.6250	21.82	M12x1-6g
B	11	.7500	24.62	M15x1-6g
C	13	.8750	28.98	M18x1-6g
D	15	1.0000	32.16	M22x1-6g
E	17	1.1875	35.33	M25x1-6g
F	19	1.2500	38.10	M28x1-6g
G	21	1.3750	41.28	M31x1-6g
H	23	1.5000	44.45	M34x1-6g
J	25	1.6250	47.63	M37x-1-6g

MIL-DTL-D38999 Series III

Straight Boot: B1 Style

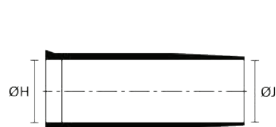

a. Expanded form (supplied)

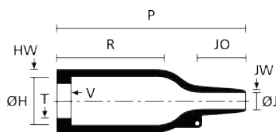

b. Fully recovered form (after heating)



a. Expanded form (supplied)

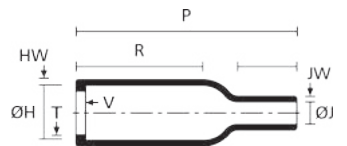

b. Fully recovered form (after heating)

Connector Shell Size	ØH Min. A	ØH Max. B	ØJ Min. A	ØJ Max. B	P ± 10%	R ± 10%	JO ± 10%	HW ± 20%	JW ± 20%	V ± 10%	T ± 20%
B=11	24.0 (.94")	10.5 (.41")	24.0 (.94")	6.0 (.23")	38.0 (1.48")	21.0 (.82")	10.0 (.39")	1.6 (.06")	0.5 (.02")	3.0 (.12")	1.0 (.04")
C=13 / D=15	25.0 (.98")	14.0 (.55")	9.0 (.35")	3.5 (.14")	55.0 (2.15")	28.0 (1.09")	16.0 (.62")	1.8 (.07")	0.5 (.02")	3.0 (.12")	1.0 (.04")
E=17 / F=19	31.0 (1.21")	18.0 (.7")	31.0 (1.21")	7.0 (.27")	67.0 (2.61")	35.0 (1.37")	18.0 (.7")	1.8 (.07")	1.0 (.04")	3.0 (.12")	1.0 (.04")
G=21 / H=23	36.0 (1.4")	22.5 (.88")	36.0 (1.4")	8.5 (.33")	80.0 (3.12")	42.0 (1.64")	20.0 (.78")	2.0 (.08")	1.0 (.04")	3.0 (.12")	1.0 (.04")
J=25	43.0 (1.68")	28.0 (1.09")	43.0 (1.68")	10.0 (.39")	79.0 (3.08")	41.0 (1.6")	20.0 (.78")	2.2 (.09")	1.0 (.04")	3.0 (.12")	1.7 (.08")

Connector Shell Size	ØH Min. A	ØH Max. B	ØJ Min. A	ØJ Max. B	P ± 10%	R ± 10%	JO ± 10%	HW ± 20%	JW ± 20%	V ± 10%	T ± 20%
A=9	16.5 (.64")	7.9 (.31")	16.5 (.64")	3.8 (.15")	25.4 (.99")	14.2 (.55")	1.3 (.05")	1.3 (.05")	3.0 (.12")	1.0 (.04")	6.9 (.27")

Dimensions in mm, inches in brackets. Subject to technical changes.

90 Degree Boot: B2 Style

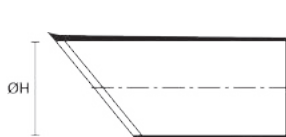

a. Expanded form (supplied)

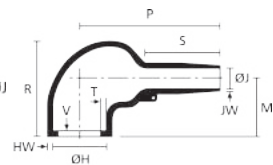

b. Fully recovered form (after heating)



a. Expanded form (supplied)

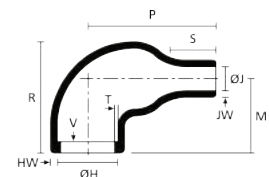

b. Fully recovered form (after heating)

Connector Shell Size	ØH Min. A	ØH Max. B	ØJ Min. A	ØJ Max. B	P ± 10%	R ± 10%	HW ± 20%	JW ± 20%	V ± 10%	T ± 20%	M Nom.	S Nom.
B=11	24.0 (.94")	10.5 (.41")	24.0 (.94")	6.0 (.23")	26.0 (1.01")	25.0 (.98")	1.3 (.05")	0.5 (.02")	3.0 (.12")	1.0 (.04")	19.0 (.74")	10.0 (.39")
C=13	30.0 (1.17")	15.5 (.6")	30.0 (1.17")	6.0 (.23")	32.0 (1.25")	27.0 (1.05")	1.5 (.06")	0.8 (.03")	3.0 (.12")	1.0 (.04")	19.0 (.74")	12.0 (.47")
D=15	31.0 (1.21")	18.0 (.7")	31.0 (1.21")	7.0 (.27")	40.0 (1.56")	31.0 (1.21")	1.8 (.07")	1.0 (.04")	3.0 (.12")	1.0 (.04")	21.0 (.82")	15.0 (.59")
E=17 F=19	36.0 (1.4")	22.5 (.88")	36.0 (1.4")	8.5 (.33")	46.0 (1.79")	38.0 (1.48")	1.8 (.07")	1.0 (.04")	3.0 (.12")	1.0 (.04")	26.0 (1.01")	15.0 (.59")
G=21 H=23	43.0 (1.68")	28.5 (1.11")	43.0 (1.68")	10.0 (.39")	55.0 (2.15")	45.0 (1.76")	2.0 (.08")	1.0 (.04")	3.0 (.12")	1.7 (.07")	30.0 (1.17")	16.0 (.62")

Connector Shell Size	ØH Min. A	ØH Max. B	ØJ Min. A	ØJ Max. B	P ± 10%	R ± 10%	HW ± 20%	JW ± 20%	V ± 10%	T ± 20%	M Nom.	S Nom.
A=9	16.5 (.64")	7.9 (.31")	16.5 (.64")	2.5 (.1")	18.3 (.71")	20.1 (.78")	1.0 (.04")	1.5 (.06")	1.6 (.06")	3.3 (.13")	1.0 (.04")	5.1 (.2")

Material Combinations:

Material Description: Fluid resistant elastomer
 Minimum Shrink Temperature: +275°F (+135°C)
 Operating Temperature Range: -103°F to +302°F
 (-75°C to +150°C)

Adhesive Specifications:

Adhesive: High performance, pre-coat, 1 part epoxy
 Operating Temperature: -94°F to +428°F
 (-75°C to +200°C)

Solvent Resistance

De-icing Fluid: Excellent
 Petrol: Excellent
 Lubricating Oil: Excellent
 Hydraulic Oil: Excellent

Dimensions in mm, inches in brackets. Subject to technical changes.

MIL-DTL-D38999 Series III

Insert Arrangements

Front Face of Pin Inserts Shown

Shell Size & Insert Arrg. for:



Series II JT				8-2	8-3		8-6		8-35	8-44		8-97	8-98			
Series I LJT					9-3		9-6	9-7		9-22	9-35	9-44		9-98		
Series III TV	7-D2	7-D3	7-D4			9-5		9-9 HD		9-35		9-94		9-98		
Service Rating	M	M	M	M	M	Grounded	M	M	N	I	M	M	M	M	I	
Number of Contacts	2	3	4	2	3	1	6	7	9	2	6	4	2	2	2	3
Contact Size	22D	22D	22D	20	20	8 Twinax	22M	22M	23	20	22D	22	20	22M	20	20

Shell Size & Insert Arrg. for:

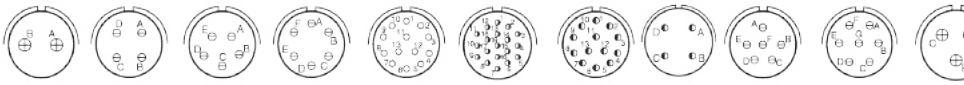

Series II JT		10-4	10-5		10-13		10-35		10-98	10-99	12-3
Series I LJT	11-2	11-4	11-5	11-6	11-13		11-35		11-98	11-99	13-3
Series III TV	11-2	11-4	11-5			11-19 HD	11-35	11-54	11-98	11-99	
Service Rating	I	I	I	I	M	N	M	II	I	I	II
Number of Contacts	2	4	5	6	13	19	13	4	6	7	3
Contact Size	16	20	20	20	22M	23	22D	22D	20	20	16

Shell Size & Insert Arrg. for:

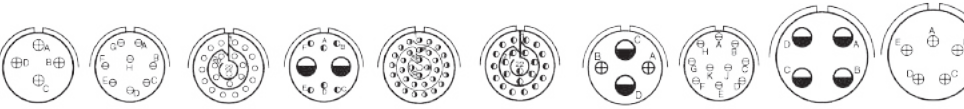

Series II JT	12-4	12-8	12-22		12-35		12-98	14-4	14-5			
Series I LJT	13-4	13-8	13-22		13-35		13-98	15-4	15-5			
Series III TV	13-4	13-8		13-26	13-32 HD	13-35	13-63	13-98	15-4	15-5		
Service Rating	I	I	M	M	N	M	I	I	I	II		
Number of Contacts	4	8	22	6	2	32	22	2	2	10	4	5
Contact Size	16	20	22M	22D	12	23	22D	16	12	20	12	16

Shell Size & Insert Arrg. for:

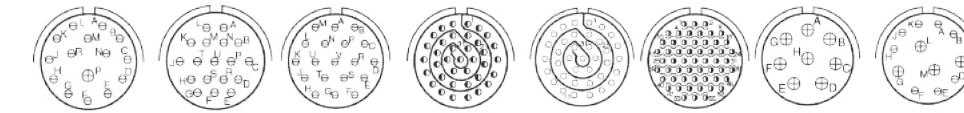

Series II JT	14-15	14-18	14-19	14-35	14-37		14-68	14-97		
Series I LJT	15-15	15-18	15-19	15-35	15-37		15-68	15-97		
Series III TV	15-15	15-18	15-19	15-35		15-55 HD		15-97		
Service Rating	I	I	I	M	M	N	I	I		
Number of Contacts	14	1	18	19	37	37	55	8	8	4
Contact Size	20	16	20	20	22D	22M	23	16	20	16

Shell Size & Insert Arrg. for:

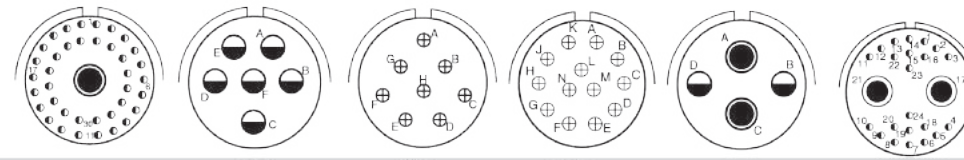

Series II JT			16-6	16-8	16-13					
Series I LJT	17-2		17-6	17-8	17-13		17-22	17-25		
Series III TV	17-2		17-6	17-8			17-22			
Service Rating		M	I	II	I		Coax	M		
Number of Contacts	38	1	6	8	13		2	2	22	2
Contact Size	22D	8 Twinax	12	16	16		12 Coax	8 Coax	22D	8 Coax

HD: High Density HD38999 (use size 23 contacts only)

CONTACT LEGEND 

MIL-DTL-D38999 Series III

Insert Arrangements

Front Face of Pin Inserts Shown

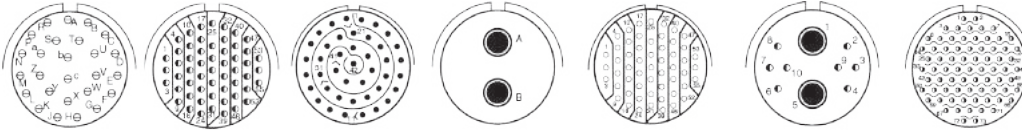

Shell Size & Insert Arrg. for:

Series II JT	16-26	16-35	16-42	16-55		
Series I LJT	17-26	17-35	17-42	17-55		
Series III TV	17-26	17-35		17-52	17-60	17-73 HD
Service Rating	I	M	M	M	M	I/Coax N
Number of Contacts	26	55	42	2	55	8 2 73
Contact Size	20	22D	22	8 Twinax	22M	22D 8 Coax

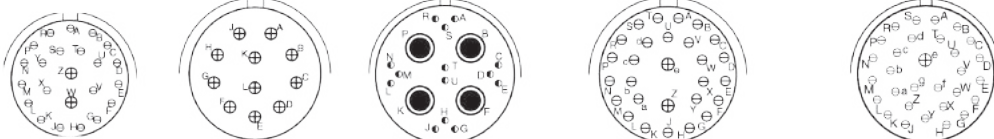

Shell Size & Insert Arrg. for:

Series II JT	16-99	18-11	18-28	18-30
Series I LJT	17-99	19-11	19-18	19-28
Series III TV	17-99	19-11	19-18	18-28
Service Rating	I	II	M	M
Number of Contacts	21 2	11	14 4	26 2
Contact Size	20 16	16	22D 8 Twinax	20 18

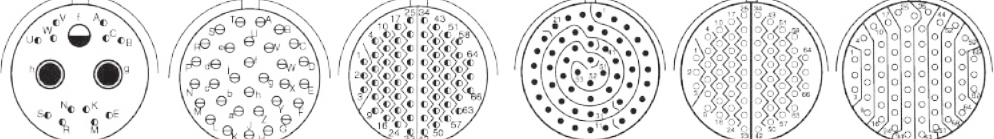

Shell Size & Insert Arrg. for:

Series II JT		18-32	18-35	18-53	18-66
Series I LJT		19-32	19-35	19-53	19-66
Series III TV	19-31	19-32	19-35		19-67
Service Rating	M	1	M	M	M
Number of Contacts	2 1 12	32	66	53	66
Contact Size	8 Coax 12 22D	20	22D	22	22M

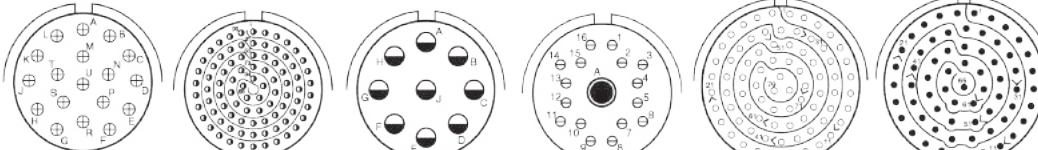

Shell Size & Insert Arrg. for:

Series II JT	18-68	18-96	20-1	20-2
Series I LJT	19-68		21-1	21-2
Series III TV		19-88 HD	19-AD	
Service Rating	I	N	I	Inst. M
Number of Contacts	18	88	9	16 1 79
Contact Size	16	23	12	20 8 Twinax 22M

CONTACT LEGEND



8	10	12	16	20	22	22M	22D	23
---	----	----	----	----	----	-----	-----	----

HD: High Density HD38999 (use size 23 contacts only)

MIL-DTL-D38999 Series III

Insert Arrangements

Front face of pin inserts shown

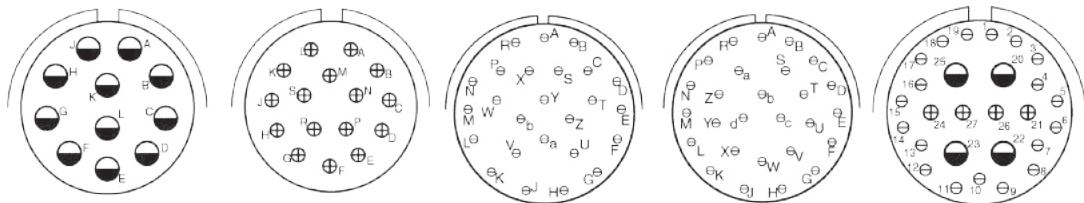

Shell Size & Insert Arrg. for:

Series II JT	20-11	20-16				
Series I LJT	21-11	21-16	21-25	21-27		
Series III TV	21-11	21-16			21-29	
Service Rating	I	II	I	I	I	I
Number of Contacts	11	16	25	27	19	4 4
Contact Size	12	16	20	20	20	16 12

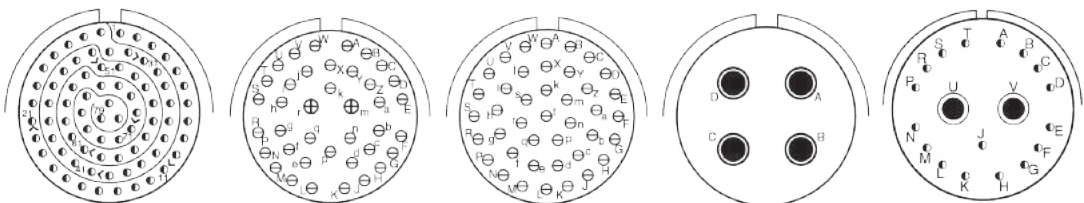

Shell Size & Insert Arrg. for:

Series II JT	20-35	20-39	20-41		
Series I LJT	21-35	21-39	21-41	21-75	21-79
Series III TV	21-35	21-39	21-41	21-75	21-79
Service Rating	M	1	I	N	II
Number of Contacts	79	37 2	41	4	17 (See Note)
Contact Size	22D	20 16	20	(See Note)	22D

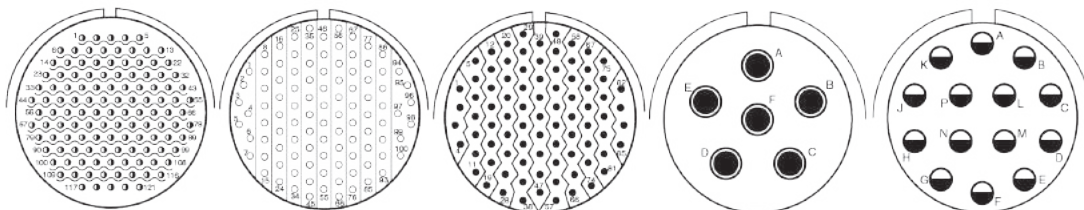

Shell Size & Insert Arrg. for:

Series II JT	22-1	22-2		22-14
Series I LJT	23-1	23-2	23-6	23-14
Series III TV	21-121 HD		23-6	
Service Rating	N	M	M	I
Number of Contacts	121	100	85	6 14
Contact Size	23	22M	22	8 Twinax 12

HD: High Density HD38999 (use size 23 contacts only)

Note: MS connector 21-75 is supplied with four size 8 twinax contacts.
Commercial connector 21-75 is supplied with four size 8 coax contacts.
MS connector 21-79 has provision for two size 8 coax contacts.
Coax contacts are not supplied unless specified by customers.



CONTACT LEGEND 8 10 12 16 20 22 22M 22D 23

MIL-DTL-D38999 Series III

Insert Arrangements

Front Face of Pin Inserts Shown

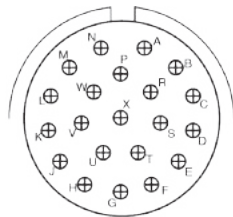

Shell Size & Insert Arrg. for:

Series II JT	22-21	22-32		22-35
Series I LJT	23-21	23-32	23-34	23-35
Series III TV	23-21			23-35
Service Rating	II	I	I	M
Number of Contacts	21	32	34	100
Contact Size	16	20	20	22D

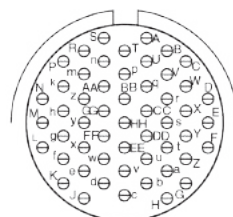
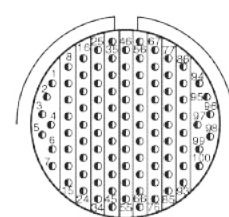
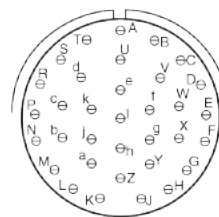
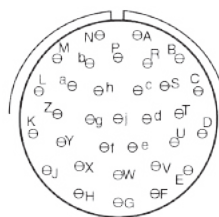

Shell Size & Insert Arrg. for:

Series II JT	22-53	22-55		
Series I LJT	23-53	23-55	23-55	23-97
Series III TV	23-53	23-54	23-55	
Service Rating	I	M	I	II
Number of Contacts	53	40 9 4	55	16
Contact Size	20	22D 16 12	20	16

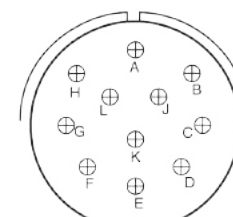
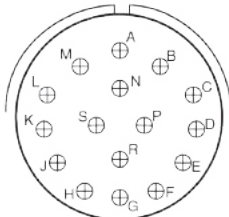
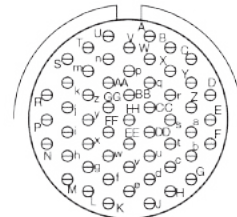
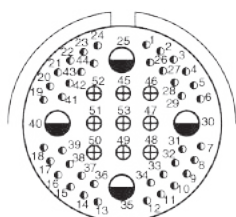

Shell Size & Insert Arrg. for:

Series II JT		24-1	24-2
Series I LJT	23-99	25-1	25-2
Series III TV		23-151 HD	
Service Rating	II	N	M
Number of Contacts	11	151	100
Contact Size	16	23	22M



CONTACT LEGEND

HD: High Density HD38999 (use size 23 contacts only)

MIL-DTL-D38999 Series III

Insert Arrangements

Front Face of Pin Inserts Shown

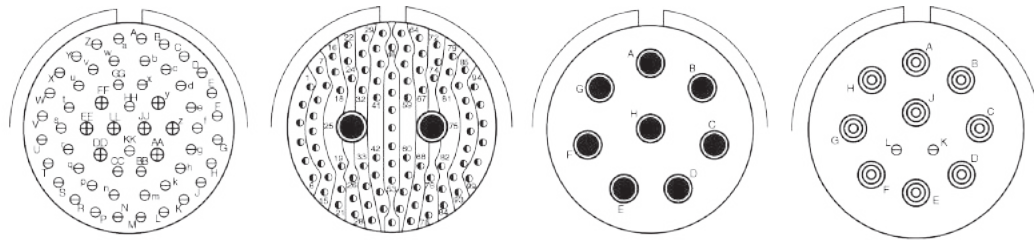

Shell Size &
Insert Arrg. for:

Series II JT	24-4							
Series I LJT	25-4		25-7				25-11	
Series III TV	25-4		25-7		25-8	25-11***		
Service Rating	I		M		Twinax	N		
Number of Contacts	48	8	97	2	8	2	9	
Contact Size	20	16	22D	8 Twinax	8 Twinax	20	10	

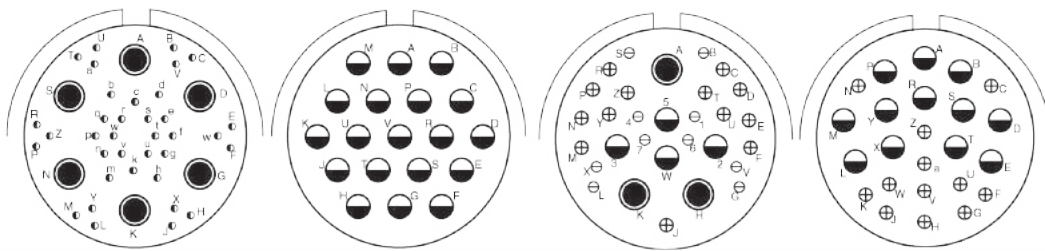

Shell Size &
Insert Arrg. for:

Series II JT	24-19		24-24					
Series I LJT	25-19		25-20		25-20	25-24		
Series III TV	25-17		25-19		25-20***		25-24	
Service Rating	M		I		N		I	
Number of Contacts	36	6	19		10	13	3	4
Contact Size	22D	8 Twinax	12		20	16	8 Twinax	12 Coax

(With Matched Impedance)

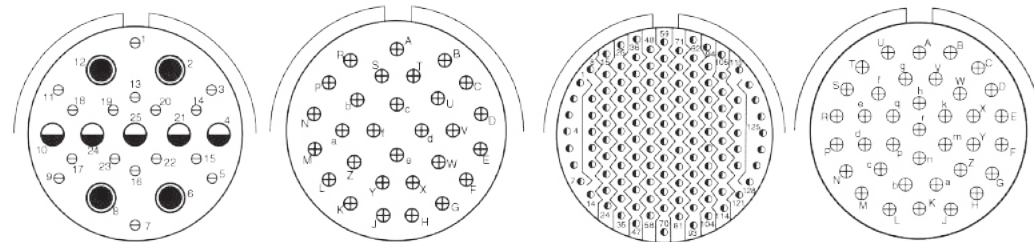

Shell Size &
Insert Arrg. for:

Series II JT	24-29		24-35		24-37			
Series I LJT	25-29		25-29		25-35	25-37		
Series III TV	25-26		25-29		25-35		25-37	
Service Rating	I		I		M	I		
Number of Contacts	16	5	4	29	128	37		
Contact Size	20	12	8 Coax	16	22D	16		

*** For use in MIL-STD-1760 applications (see pages 43 and 44).



CONTACT LEGEND 8 10 12 16 20 22 22M 22D 23

MIL-DTL-D38999 Series III

Insert Arrangements

Front Face of Pin Inserts Shown

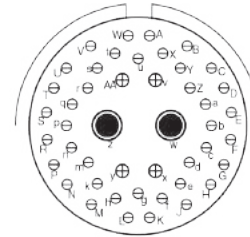
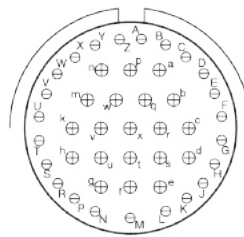
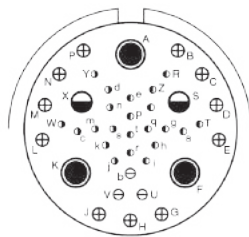

Shell Size &
Insert Arrg. for:

Series II JT							25-43			
Series I LJT							25-43		25-46	
Series III TV	25-41						25-43		25-46	
Service Rating	N/Inst.						I		I	
Number of Contacts	22	3	11	2	3	23	20	40	4	2
Contact Size	22D	20	16	12 Coax	8 Twinax	20	16	20	16	8 Coax †

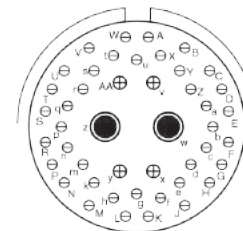
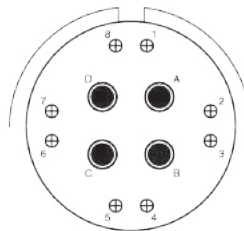
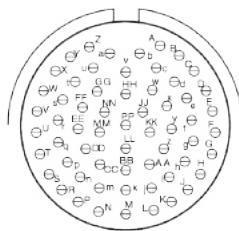

Shell Size &
Insert Arrg. for:

Series II JT	24-61		25-62		25-90	
Series I LJT	25-61					
Series III TV	25-61		25-62		25-90	
Service Rating	I		I		I	
Number of Contacts	61		8 4		40 4 2	
Contact Size	20		16 8		20 16 8 Twinax	

Ground Plane
Only

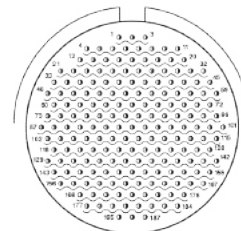
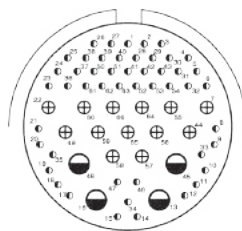

Shell Size &
Insert Arrg. for:

Series II JT				25-F4			25-187 HD		
Series I LJT									
Series III TV	25-F4			25-187 HD					
Service Rating	Size 22D=M, Balance =I			N					
Number of Contacts	49	13	4	187					
Contact Size	22D	16	12	23					



† Coax contacts for RG180/U or RG195/U cable.

HD: High Density HD38999
(use size 23 contacts only)

MIL-DTL-D38999 Series III

BK4S Backshell Drawing

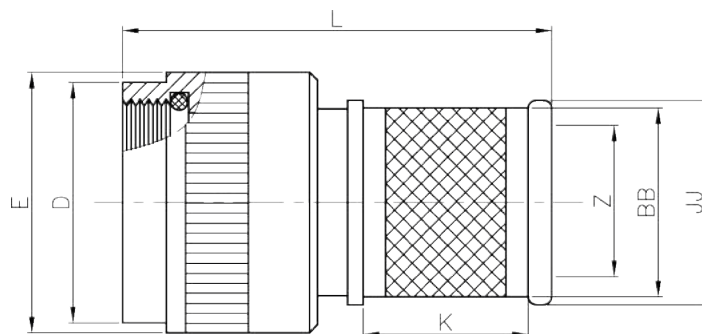

Shell Size Designator	A Thread Class 2B	ØD ± 1.5		ØE +0.20 -0.00		ØZ Cable Max.		ØBB Max.		ØJJ Max.		K Max.		L Max.	
		INCH	MM	INCH	MM	INCH	MM	INCH	MM	INCH	MM	INCH	MM	INCH	MM
8	09/A	0.596	15.14	0.674	17.14	0.281	7.2	0.391	9.9	0.486	12.3	0.433	11.0	1.970	50.0
10	11/B	0.712	18.11	0.791	20.11	0.338	8.6	0.493	12.5	0.587	14.9	0.433	11.0	2.090	53.1
12	13/C	0.829	21.08	0.908	23.08	0.506	12.9	0.665	16.9	0.783	19.9	0.476	12.1	2.100	53.3
14	15/D	0.985	25.04	1.064	27.04	0.562	14.3	0.744	18.9	0.862	21.9	0.476	12.1	2.210	56.1
16	17/E	1.103	28.02	1.181	30.02	0.619	15.7	0.821	20.9	0.939	23.9	0.476	12.1	2.280	57.9
18	19/F	1.220	30.99	1.298	32.99	0.675	17.1	0.891	22.6	1.010	25.6	0.476	12.1	2.360	59.9
20	21/G	1.337	33.96	1.415	35.95	0.731	18.6	0.954	24.2	1.072	27.2	0.476	12.1	2.400	61.0
22	23/H	1.448	36.80	1.527	38.80	0.843	21.4	1.095	27.8	1.213	30.8	0.476	12.1	2.520	64.0
24	25/J	1.566	39.78	1.644	41.78	0.900	22.86	1.160	29.4	1.276	32.4	0.476	12.1	2.520	64.0

MIL-DTL-D38999 Series III

Other Backshell Types

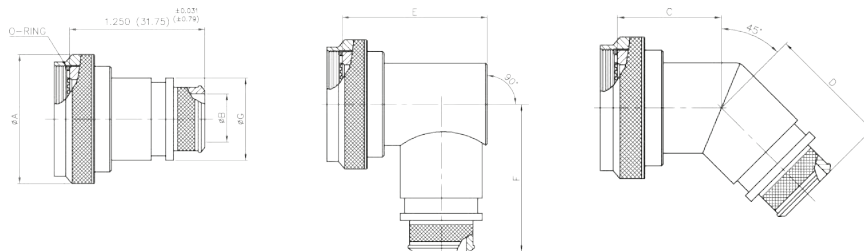

All dimensions are in INCHES (mm)

Part Numbering System

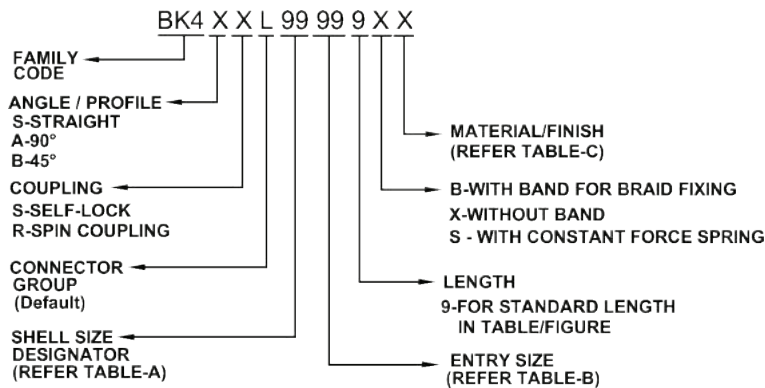

Table B

ENTRY SIZE	ØB +0.010-0.020 (+0.25-0.50)		ØG MAX	
	INCH	MM	INCH	MM
02	0.124	3.17	0.208	9.80
03	0.187	4.75	0.528	13.40
04	0.250	6.35	0.547	13.90
05	0.311	7.92	0.591	15.00
06	0.374	9.52	0.657	16.70
07	0.437	11.12	0.717	18.20
08	0.500	12.70	0.780	19.80
09	0.562	14.30	0.843	21.40
10	0.625	15.88	0.906	23.00
11	0.688	17.50	0.969	24.60
12	0.750	19.05	1.031	26.20
13	0.812	20.65	1.094	27.80
14	0.875	22.23	1.157	29.40
15	0.938	23.83	1.220	31.00
16	1.000	25.40	1.283	32.60
17	1.082	27.50	1.346	34.20
18	1.125	28.58	1.409	35.80
19	1.208	30.70	1.472	37.40
20	1.250	31.75	1.535	39.00
21	1.333	33.88	1.598	40.60
22	1.374	34.92	1.661	42.20
23	1.440	36.58	1.744	44.29
24	1.500	38.10	1.787	45.40

Table A

SHELL SIZE DESIGNATOR	MAX. ENTRY SIZE (Normal Style)	CONNECTOR SHELL SIZE/CODE	ØA MAX.		C MAX.		D MAX.		F MAX.		E MAX.	
			INCH	MM	INCH	MM	INCH	MM	INCH	MM	INCH	MM
08	04	09/A	0.86	21.82	0.519	13.20	1.150	29.21	1.279	32.51	0.839	21.33
10	06	11/B	0.99	25.04	0.540	13.72	1.170	29.72	1.339	34.03	0.970	24.64
12	08	13/C	1.16	29.36	0.570	14.48	1.200	30.50	1.409	35.81	1.090	27.69
14	10	15/D	1.28	32.54	0.590	14.99	1.230	31.25	1.469	37.33	1.219	30.98
16	12	17/E	1.41	35.71	0.620	15.75	1.250	31.75	1.529	38.86	1.339	34.03
18	14	19/F	1.52	38.51	0.629	16.00	1.259	32.00	1.589	40.38	1.409	35.81
20	15	21/G	1.64	41.68	0.659	16.76	1.289	32.76	1.659	42.16	1.529	38.86
22	17	23/H	1.77	44.86	0.681	17.30	1.320	33.53	1.719	43.68	1.659	42.16
24	20	25/J	1.89	48.03	0.708	18.00	1.339	34.03	1.779	45.21	1.779	45.21

All dimensions are in INCHES (mm)

Table C

Code	Material/Finish
N	Aluminium Alloy/Electroless Nickel
W	Aluminium Alloy/Cadmium Olive drab over Electroless Nickel.
Y	Aluminium Alloy/Zinc-cobalt dark olive drab over Electroless Nickel.
TN	Aluminum Alloy/Nickel Teflon
ZN	Aluminum Alloy/Zinc Nickel
S	Stainless Steel/Passivate
K	Nickle Aluminium Bronze/Shot blast
P	Aluminium Alloy/Cadmium Olive drab over Electroless Nickel. (SELECTIVE PLATING)

Note: When maximum Cable Entry Exceed's consult MATEC Electronics.



MATEC Electronics is an authorized and leading distributor, that specializes on the design and custom-engineered connectors, cables and electronic interconnect solutions for Military-Aerospace, Industry and Telecom market fields. MATEC's deep technical and commercial knowledge on it's concentrated product portfolio has made the company the chosen distributor of the customers in the region it serves Turkey, Middle East, Africa, Eastern Europe. MATEC Electronics mainly distributes world's leading interconnect manufacturer, Amphenol. The company provides not only sales channel for Amphenol, but also give services to it's valuable customers with highly experienced field application engineers and inside customer services.

Add to the large product portfolio of Amphenol, MATEC Electronics also represents Reflex Photonics, Enargy Power and Bufab.

Head Office

Ahi Evran Cad. No: 21
Kat: 4 Daire: 24
Polaris Plaza Maslak,
Sariyer, ISTANBUL

Branch Office

Bestepe Mah.
Nergis Sok. Via Flat
Kat: 3 No: 7/2
Sogutozu, ANKARA

Warehouse

Tatlisu Mah.
Ersoy Sok.
No: 3
Umraniye, ISTANBUL

www.matec.com.tr
info@matec.com.tr
+90 216 365 80 10