

# Connectors and Accessories Selection Guide

## 62IN Series

For Military, Aerospace & Harsh Environments.



WE'RE MATING TECHNOLOGY WITH CONFIDENCE



[www.matec.com.tr](http://www.matec.com.tr)

## About MATEC

MATEC Electronics is an authorized and leading distributor, that specializes on the design and custom-engineered connectors, cables and electronic interconnect solutions for Military-Aerospace, Industrial and Telecom market fields. MATEC's deep technical and commercial knowledge on it's concentrated product portfolio has made the company the chosen distributor of the customers in the region it serves, Turkey, Middle East, Africa and Eastern Europe. Headquartered in Istanbul, MATEC also has a branch office in Ankara and warehouses in Istanbul and NY, U.S.A. With it's highly experienced team, knowledge on dynamic supply chain solutions and rich inventory, MATEC has provided it's customer with the best technical and commercial service along with the quality products since it was founded in 2011. Our first priority is complete customer satisfaction. While MATEC's IPC/WHMA-A-620 certified technical team acts as design partner in your projects, the company commercial team ensures that the service given has it is highest achievable standards. Due to the fact that MATEC Electronics works with the world's well-known companies, it offers its products with proven quality to its customers. We are ISO 9001:2015 registered and dedicated to use those guidelines for your satisfaction.

## Contact Us

### Head Office

Ahi Evran Cad. N: 21  
Kat: 4 Daire: 24  
Polaris Plaza Maslak,  
Sariyer, ISTANBUL

Phone: +90 212 346 16 06

### Branch Office

Bestepe Mah. Nergis Sok.  
Via Flat  
Kat: 3 No: 7/2  
Sogutozu, ANKARA

### Warehouse

Tatlisu Mah.  
Ersoy Sok.  
No: 3  
Umraniye, ISTANBUL

Phone: +90 216 365 80 10  
Fax: +90 216 365 80 10



[www.matec.com.tr](http://www.matec.com.tr)

[info@matec.com.tr](mailto:info@matec.com.tr)



## How We Serve

As a leading and authorized distributor, MATEC Electronics supports all types electrical interconnect requirements of Mil-Aero projects. MATEC is not only able to provide solutions to electronic interconnect requirements technically, but it also provides best commercial experience to its customers with dynamic team.

5015 Series Connectors



Backshells



26482 Series Connectors

## Inventory Solutions

In addition to commercial and customized harsh environment Mil-Aero series, MATEC also offers most popular qualified Mil-Spec versions for all type of your projects from it's inventory. MATEC also supports all type of connector accessory requirements like strain reliefs, backshells, heat shrink tubes and contacts, providing order-to-manufacture kit solutions.

D38999 Series Connectors



### Boots



2M Series Connectors

## Amphenol 62IN Series

Amphenol 62IN series connectors are general purpose, environment resistant, miniature circular connectors with three-point bayonet coupling and five-key polarisation. Designed to meet the requirements of MIL-C-26482, Series I solder type, these connectors are widely used in applications calling for quick disconnect connectors. 62IN connectors are intermateable and interchangeable with all MIL-C-26482 connectors, whether solder or crimp type. These connectors are used worldwide in military and industrial applications and are available in a variety of sizes, styles and configurations.

**Temperature:** -55°C to +125°C

**Accessory Requirements:** Various Backshells available for different requirements

**Three Point Bayonet Coupling and Five-Key Polarisation:** Audible and tactile indication of full coupling

**Corrosion Resistance:** Rugged construction; aluminum or stainless steel components

Current Rating			
Contact Size	Rated Current	Test Current	Potential Drop
20	7.5A	7.5A	≤ 55mV
16	13A	13A	≤ 50mV

Voltage Rating (Max. Operating Voltage at Sea Level)	
Service Rating	AC (rms)
I	600V
II	1000V

Voltage Proof	
Service Rating	Test Voltage
I	1500V
II	2300V

Wire Range Accommodations	
Contact Size	AWG Wire Size
20	24, 22 and 20
16	20, 18 and 16

**Applications:** Military / Harsh Environment Industrial

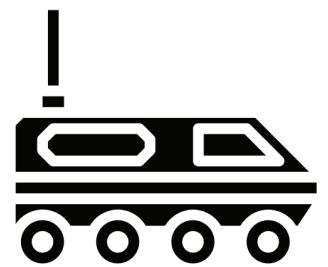

## Amphenol 62IN Series

### How to Order

62IN 5 7 E 18 32 P W B1 XX

**Series Designation:** \_\_\_\_\_

62IN - MIL -C-26482 series I miniature bayonet lock

**Key Specification:** \_\_\_\_\_

- 1) -as per MIL-C-26482
- 5) -as per BS 9522 F0017

**Shell Style:** \_\_\_\_\_

- 0) Wall Mounting Receptacle
- 1) Cable Connecting Receptacle
- 2) Box Mounting Receptacle,
- 4) Jam Nut Receptacle Internality Threaded with Cable Accessories
- 5) Plug without back accessories
- 6) Plug
- 7) Jam Nut Receptacle, plain shell
- 8) Right Angle Back Shell With Cable Clamp (Less Grommet)

**Connector Class:** \_\_\_\_\_

- A: Plain shell, exposed solder Buckets, no grommet.
- E: Insert and grommet with Grommet nut (excluding 12E Which has plain shell and no Grommet or grommet nut).
- F: Same as E, but grommet nut With strain relief clamp.
- J: Same as E, but with resilient Gland seal and nut for Unscreened jacketed cable, No grommet.
- T: Threaded shell for cable Accessories, exposed solder Buckets.
- TG: Same as T, but shell has Grounding fingers. (Only for plug connectors)
- TBK4S: Connector Supplied with EMI Backshell with constant force spring & conductive tape.
- TGBK4S: Same as TG but connector supplied with EMI Backshell with constant force spring & conductive tape.
- PG: Plug with straight PG threaded Backshell
- PHM: Supplied with different diameter sleeves to suit varying cable sizes. Used for unshielded cables
- EGM: Supplied with different diameter sleeves to suit varying cable sizes. Used for shielded cables
- SQ: Used for shielded cables
- SB: Used for unshielded cables

**Deviations**

- \*\*\* See next page for standard deviations
- \*\*\* Contact with MATEC Electronics for non-standard platings and special deviations

**Boot Options**

- B1: Straight Boot
- B2: 90 Degree Boot

**Orientation**

- Inserts - W - X - Y - Z (Omit for normal)
- Or Key/Keyway - B - C - E - F

**Contact Style**

- P - Pin contacts
- S - Socket contacts

**Shell Size & Insert Arrangement**

- \*\*\* See section "Insert Arrangements"

**Notes:**

Standard-Cadmium plating with olive drab chromate finish

## Amphenol 62IN Series

### How to Order

### Standard Deviations

Deviation Number	Description
(4)	Gold flash on contacts
(5)	Crimp contact
(044)	Rough grip heavy duty coupling ring (for plugs only)
(218)	Coupling ring with lever arrangement
(219)	Film wire termination (short) for flexible printed wiring (57A and 12E styles only)
(220)	Film wire termination (long) for flexible printed wiring (57A and 12E styles only)
(416)	Electroless Nickel Plating
*(608)	Black anodised finish
(622)	Cadmium free zinc-cobalt Plating-olive drab finish
(624)	Cadmium free zinc-cobalt Plating-black finish
(0PX)	Premating contact (X denotes premating contact designation)
(714)	Cadmium over electroless Nickel
(720)	Cadmium plating with black chromate
(725)	Zinc plating with olive drab finish
(726)	Electrophoretic Finish
(56T)	Plug connector with threaded shell & serration to accept the cable accessories
(15A)	Plug connector with threaded shell to accept the cable accessories
(LC)	Less contact
(N00)	Connector without marking
(N01)	Connector with customer requested marking

## Amphenol 62IN Series Wall Mounting Receptacles

### 62IN 10

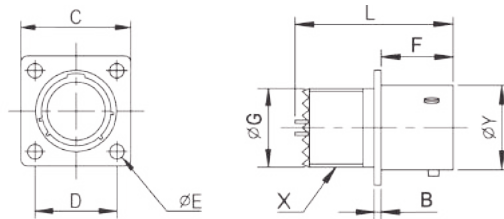

Shell Size	B	C	D	E Dia	F	G Dia	L	Y Dia	X Threads in Inches
8	1.58	20.75	15.09	3.05	11.30	11.02	24.84	12.02	7/16-28 UNEF
10	1.58	23.93	18.26	3.05	11.30	14.17	24.84	14.99	9/16-24 UNEF
12	1.58	26.32	20.63	3.05	11.30	17.35	24.84	19.05	11/16-24 UNEF
14	1.58	28.70	23.10	3.05	11.30	20.52	24.84	22.23	13/16-20 UNEF
16	1.58	31.07	24.61	3.05	11.30	23.70	24.84	25.40	15/16-20 UNEF
18	1.58	33.45	26.58	3.05	11.30	26.85	24.84	28.58	1 1/16-18 NEF
20	2.03	36.63	29.36	3.05	14.10	30.02	26.62	31.75	1 3/16-18 NEF
22	2.03	39.80	31.75	3.05	14.10	30.02	26.62	34.93	1 5/16-18 NEF
24	2.03	42.98	34.93	3.74	14.99	36.37	26.62	38.10	1 7/16-18 NEF

\*Without Termination Assemblies

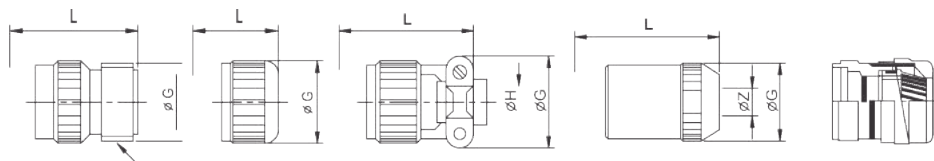

Style 10A

Style 10E

Style 10F

Style 10J

10PHM/EGM

Shell Size	Style 10A			Style 10E		Style 10F			Style 10J			
	G Dia	L	M Thread in Inches	G Dia	L	G Dia	H Dia	L	G Dia	L	For Cable Size Z Dia	
											Min	Max
8	14.25	41.25	1/2-28 UNEF	14.25	32.54	21.03	3.96	44.76	14.25	46.89	4.28	5.84
10	17.43	41.25	5/8-24 NEF	17.43	32.54	22.63	4.78	44.76	17.43	46.89	5.21	7.93
12	20.60	41.25	3/4-20 UNEF	20.60	32.54	25.81	7.93	44.76	20.80	49.95	8.59	11.23
14	23.78	41.25	7/8-20 UNEF	23.78	32.54	28.98	9.58	44.10	23.78	54.54	10.57	13.69
16	26.98	41.25	1-20 UNEF	26.98	32.54	30.56	12.70	47.65	26.98	59.61	13.97	15.65
18	31.12	41.25	1 3/16-18 NEF	30.12	32.54	36.22	15.87	47.65	30.12	64.70	15.24	17.07
20	33.30	42.85	1 3/16-18 NEF	33.30	35.13	36.22	15.87	53.80	33.30	71.91	16.13	18.98
22	36.47	42.85	1 7/16-18 NEF	36.47	35.13	39.80	19.05	53.80	36.47	76.99	17.02	21.49
24	39.65	43.94	1 7/16-18 NEF	39.65	35.13	44.07	30.32	57.15	39.65	78.08	18.80	22.71

\*With Termination Assemblies



## Amphenol 62IN Series Cable Mounting Receptacles

### 62IN 11

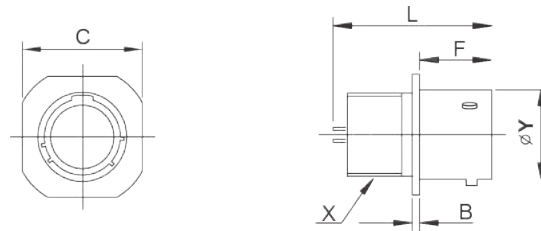

Shell Size	B	C	F	L	Y Dia	X Threads in Inches
8	2.39	20.75	10.54	24.84	12.03	7/16-28 UNEF
10	2.39	23.93	10.54	24.84	14.99	9/16-24 NEF
12	2.39	26.32	10.54	24.84	19.05	11/16-24 NEF
14	2.39	28.70	10.54	24.84	22.23	13/16-20 UNEF
16	2.39	31.07	10.54	24.84	25.40	15/16-20 UNEF
18	2.39	33.45	10.54	24.84	28.58	1 1/16-18 NEF
20	2.59	36.63	13.59	26.62	31.75	1 3/16-18 NEF
22	2.59	39.80	13.59	26.62	34.93	1 5/16-18 NEF
24	2.59	42.98	14.53	26.62	38.10	1 7/16-18 NEF

\*Without Termination Assemblies.

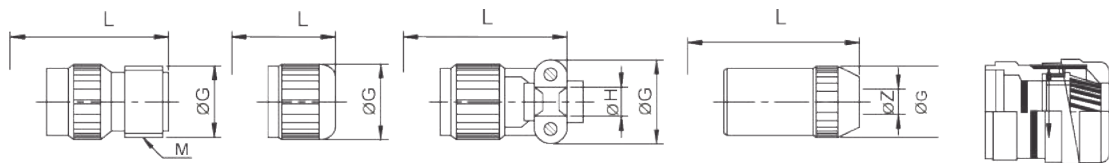

Style 11A

Style 11E

Style 11F

Style 11J

11PHM/EGM

Shell Size	Style 11A			Style 11E		Style 11F			Style 11J			
	G Dia	L	M Thread in Inches	G Dia	L	G Dia	H Dia	L	G Dia	L	For Cable Size Z Dia	
											Min	Max
8	14.25	41.25	1/2-28 UNEF	14.25	32.54	21.03	3.96	44.76	14.25	46.9	4.28	5.84
10	17.43	41.25	5/8-24 NEF	17.43	32.54	22.63	4.78	44.76	17.43	46.89	5.21	7.93
12	20.60	41.25	3/4-20 UNEF	20.60	32.54	25.81	7.93	44.76	20.60	49.45	8.59	11.23
14	23.78	41.25	7/8-20 UNEF	23.78	32.54	28.97	9.53	44.10	23.78	54.54	10.57	13.69
16	26.95	41.25	1-20 UNEF	26.95	32.54	30.56	12.70	47.65	26.95	59.61	13.97	15.65
18	30.13	41.25	1 3/16-18 NEF	30.13	32.54	36.22	15.88	47.65	30.13	64.70	15.24	17.07
20	33.30	42.85	1 3/16-18 NEF	33.30	35.13	36.22	15.88	53.80	33.30	71.91	16.13	18.98
22	36.75	42.85	1 7/16-18 NEF	36.75	35.13	39.80	19.05	53.80	36.75	76.99	17.02	21.49
24	39.65	43.95	1 7/16-18 NEF	39.65	35.13	44.07	20.32	57.15	39.65	78.03	18.80	22.71

\*With Termination Assemblies.

## Amphenol 62IN Series Box Mounting Receptacles

### 62IN 12

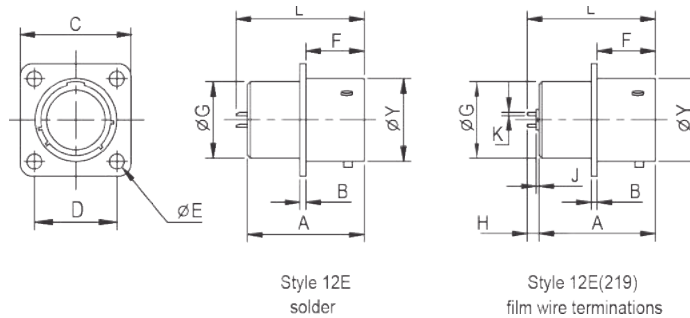

Shell Size	B	C	D	E Dia	F	G Dia	Y Dia	Style 12E		Style 12E (219)						
								A	L	A	H		J	K		L
											Min.	Max.		Min.	Max.	
8	1.58	20.75	15.09	3.05	11.30	11.02	12.02	20.32	24.84	20.32	4.22	5.03	2.26	0.70	0.76	24.95
10	1.58	23.93	18.26	3.05	11.30	14.17	14.99	20.32	24.84	20.32	4.22	5.03	2.26	0.70	0.76	24.95
12	1.58	26.32	20.63	3.05	11.30	17.35	19.05	20.32	24.84	20.32	4.22	5.03	2.26	0.70	0.76	24.95
14	1.58	28.70	23.10	3.05	11.30	20.52	22.23	20.32	24.84	20.32	4.22	5.03	2.26	0.70	0.76	24.95
16	1.58	31.07	24.61	3.05	11.30	23.70	25.40	20.32	24.84	20.32	4.22	5.03	2.26	0.70	0.76	24.95
18	1.58	33.45	26.58	3.05	11.30	26.85	28.58	20.32	24.84	20.32	4.22	5.03	2.26	0.70	0.76	24.95
20	2.03	36.63	29.36	3.05	14.10	30.02	31.75	22.23	26.62	22.23	3.89	4.70	1.93	0.70	0.76	26.85
22	2.03	39.80	31.75	3.05	14.10	30.02	34.93	22.23	26.62	22.23	3.89	4.70	1.93	0.70	0.76	26.85
24	2.03	42.98	34.93	3.74	14.99	36.37	38.10	22.23	26.62	22.23	3.89	4.70	1.93	0.70	0.76	26.85

\*Without Termination Assemblies.

### Mounting data Panel cutouts Wall mounting receptacles

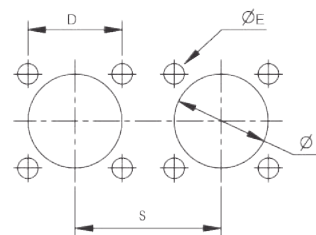
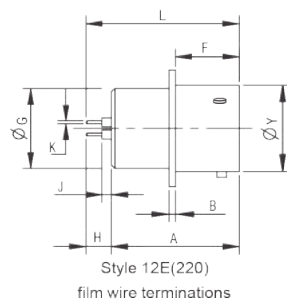

Shell Size	A	H		J	K		L
		Min.	Max.		Min.	Max.	
8	20.32	7.95	8.00	4.60	0.70	0.76	28.32
10	20.32	7.95	8.00	4.60	0.70	0.76	28.32
12	20.32	7.95	8.00	4.60	0.70	0.76	28.32
14	20.32	7.95	8.00	4.60	0.70	0.76	28.32
16	20.32	7.95	8.00	4.60	0.70	0.76	28.32
18	20.32	7.95	8.00	4.60	0.70	0.76	28.32
20	22.23	7.95	8.00	4.60	0.70	0.76	30.23
22	22.23	7.95	8.00	4.60	0.70	0.76	30.23
24	22.23	7.95	8.00	4.60	0.70	0.76	30.23

Shell Size	D	E Dia	R Dia	S
8	15.09	3.05	14.42	31.73
10	18.29	3.05	17.53	34.52
12	20.75	3.05	21.84	38.89
14	23.11	3.05	25.15	42.06
16	24.64	3.05	28.19	45.24
18	26.46	3.05	31.49	48.03
20	29.46	3.05	35.54	51.59
22	31.75	3.05	37.85	52.76
24	35.05	3.05	41.15	57.84

\*With Termination Assemblies.

## Amphenol 62IN Series

### Jam Nut Receptacles

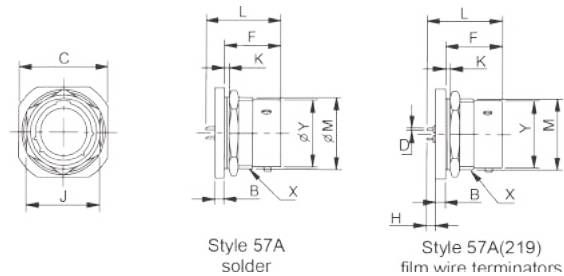

Shell Size	B	C	D		F	H		J	K Panel Thickness		Style 57A L	Style 57A (219) L	M Dia.	Y Dia.	X Thread in Inches.
			Min.	Max.		Min.	Max.		Min.	Max.					
8	2.97	23.93	0.70	0.76	17.93	3.38	4.40	19.05	1.58	3.18	24.84	24.84	13.39	12.03	9/16-24 NEF
	2.97	27.10	0.70	0.76	17.93	3.38	4.40	22.23	1.58	3.18	24.84	24.84	16.56	14.99	1/16-24 NEF
12	2.97	31.88	0.70	0.76	17.93	3.38	4.40	26.98	1.58	3.18	24.84	24.84	20.70	19.05	7/8-20 UNEF
14	2.97	35.05	0.70	0.76	17.93	3.38	4.40	30.15	1.58	3.18	24.84	24.84	23.85	22.23	1-20 UNEF
16	2.97	38.23	0.70	0.76	17.93	3.38	4.40	33.32	1.58	3.18	24.84	24.84	27.00	25.40	1 1/8-18 NEF
18	2.97	41.40	0.70	0.76	17.932	3.38	4.40	36.50	1.58	3.18	24.84	24.84	30.18	28.58	1 1/4-18 NEF
20	3.76	46.15	0.70	0.76	22.71	3.38	4.40	38.68	1.58	6.35	26.62	30.35	33.35	31.75	1 3/8-18 NEF
22	3.76	49.33	0.70	0.76	22.71	3.38	4.40	42.85	1.58	6.35	26.62	30.35	36.53	34.93	1 1/2-18 NEF
24	3.76	52.50	0.70	0.76	22.71	3.38	4.40	46.05	1.58	6.35	26.62	30.35	39.70	38.10	1 5/8-18 NEF

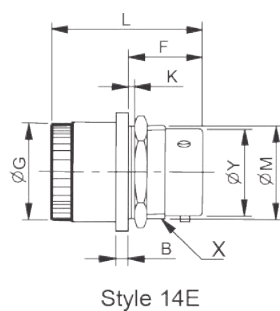

### Mounting data Panel cutouts

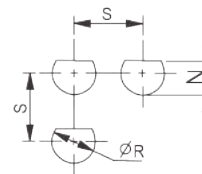

Shell Size	G Dia.	L
8	18.11	34.14
10	21.29	34.14
12	24.46	34.14
14	27.63	34.14
16	30.81	34.14
18	33.98	34.14
20	37.16	40.03
22	40.33	40.03
24	43.51	40.87

Shell Size	N	R Dia.	S
8	13.72	14.53	31.75
10	16.89	17.70	34.52
12	21.03	22.48	38.89
14	24.18	25.65	42.06
16	27.33	28.83	45.24
18	30.50	32.00	48.03
20	33.68	35.18	51.59
22	36.86	38.35	54.76
24	40.03	41.45	57.84

## Amphenol 62IN Series

### Jam Nut Receptacles

#### 62IN - 57T

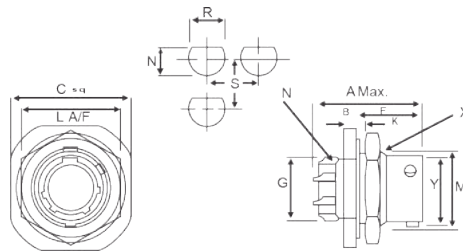

Shell Size	A Max.	B ± 0.05 (+0.013)	C Max. Sq.	F ±0.005 (+0.13)	G Dia. Max.	K		L	M -0.005 (-0.13)	N	Y	X Thread
						Min.	Max.					
8	0.978 24.84	0.117 2.97	0.942 23.93	0.595 15.12	0.426 10.82	0.062 1.58	0.125 3.58	0.750 19.05	0.527 13.3	7/16 UNE-F	0.473 12.03	9/16-24 UNEF
10	0.978 24.84	0.117 2.97	1.067 27.10	0.595 15.12	0.552 14.02	0.062 1.58	0.125 3.58	0.875 22.23	0.652 16.56	9/16 UNE-F	0.590 14.99	11/16-24 UNEF
12	0.978 24.84	0.117 2.97	1.255 31.88	0.595 15.12	0.677 17.20	0.062 1.58	0.125 3.58	1.062 26.98	0.825 20.70	11/16 UNE-F	0.750 19.05	7/8-20 UNEF
14	0.978 24.84	0.117 2.97	1.380 35.05	0.595 15.12	0.802 20.37	0.062 1.58	0.125 3.58	1.187 30.15	0.939 23.85	13/16 UNE-F	0.875 22.23	1-20 UNEF
16	0.978 24.84	0.117 2.97	1.505 38.23	0.595 15.12	0.927 23.55	0.062 1.58	0.125 3.58	1.312 33.32	1.063 27.00		1.000 25.40	1.1/18-18 UNEF
18	0.978 24.84	0.117 2.97	1.630 41.40	0.595 15.12	1.052 26.72	0.062 1.58	0.125 3.58	1.437 36.50	1.188 30.18	15/16 UNE-F	1.125 28.58	1.1/4-18 UNEF
20	1.978 26.62	0.148 3.76	1.817 46.15	0.720 18.29	1.167 29.65	0.062 1.58	0.250 6.35	1.562 39.68	1.313 33.35	1.3/16 UNE-F	1.250 31.75	1.3/8-18 UNEF
22	1.978 26.62	0.148 3.76	1.942 49.33	0.720 18.29	1.292 32.82	0.062 1.58	0.250 6.35	1.687 42.85	1.438 36.53	1.5/16 UNE-F	1.375 34.93	1.1/2-18 UNEF
24	1.978 26.62	0.148 3.76	2.067 52.50	0.753 19.13	1.416 35.97	0.062 1.58	0.250 6.35	1.812 46.05	1.563 39.70	1.7/16 UNE-F	1.500 38.10	1.5/8-18 UNEF

\*All dimensions in mm.

#### 62IN - 14F

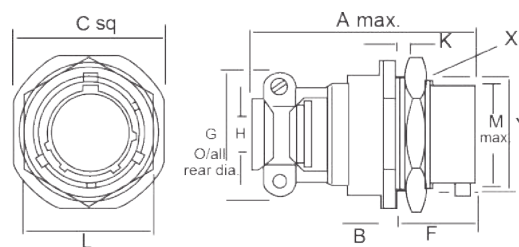

Shell Size	A Max.	B ± 0.05 (+0.013)	C Max. Sq.	F ±0.005 (+0.13)	G Dia. Max.	H Max. ± 0.005 (+0.13)	K		L	M -0.005 (-0.13)	N -0.005 (-0.13)	R 0.005 (-0.13)	S	Y	X Thread
							Min.	Max.							
8	1.762 44.75	0.117 2.97	0.942 23.93	0.706 17.93	0.828 21.03	0.156 3.96	0.062 1.58	0.125 3.175	0.750 19.05	0.527 13.3	0.540 13.72	0.572 14.53	1.250 31.75	0.473 12.03	9/16-24 UNEF
10	1.762 44.75	0.117 2.97	1.067 27.10	0.706 17.93	0.891 22.63	0.188 4.78	0.062 1.58	0.125 3.58	0.875 22.23	0.652 16.56	0.665 16.89	0.697 17.70	1.359 34.52	0.590 14.99	11/16-24 UNE-F
12	1.762 44.75	0.117 2.97	1.255 31.88	0.706 17.93	1.016 25.81	0.312 7.93	0.062 1.58	0.125 3.58	1.062 26.98	0.815 20.70	0.828 21.03	0.885 22.48	1.531 38.89	0.750 19.05	7/8-20 UNEF
14	1.876 47.65	0.117 2.97	1.380 35.05	0.706 17.93	1.141 28.97	0.375 9.35	0.062 1.58	0.125 3.58	1.187 30.15	0.939 23.85	0.952 24.18	1.010 25.65	1.656 42.06	0.875 22.23	1-20 UNEF
16	1.876 47.65	0.117 2.97	1.505 38.23	0.706 17.93	1.203 30.56	0.500 12.7	0.062 1.58	0.125 3.58	1.312 33.32	1.063 27.00	1.076 27.33	1.135 28.83	1.781 45.24	1.000 25.40	1.1/8-18 UNEF
18	1.876 47.65	0.117 2.97	1.630 41.40	0.706 17.93	1.426 36.22	0.625 16.88	0.062 1.58	0.125 3.175	1.437 36.50	1.188 30.18	1.201 30.50	1.260 32.00	1.891 48.03	1.125 28.58	1.1/4-18 UNEF
20	2.118 53.8	0.148 3.76	1.817 46.15	0.894 22.71	1.426 36.22	0.625 15.88	0.062 1.58	0.250 6.35	1.562 39.68	1.313 33.35	1.326 33.68	1.385 35.18	2.031 51.59	1.250 31.75	1.3/8-18 UNEF
22	2.118 53.8	0.148 3.76	1.942 49.33	0.894 22.71	1.567 39.80	0.750 19.05	0.062 1.58	0.250 6.35	1.687 42.85	1.438 36.53	1.451 36.86	1.510 38.35	2.156 54.76	1.375 34.93	1.1/2-18 UNEF
24	2.250 57.15	0.148 3.76	2.067 52.50	0.894 22.71	1.735 44.07	0.800 20.32	0.062 1.58	0.250 6.35	1.812 46.05	1.563 39.70	1.576 40.03	1.635 41.45	2.277 57.84	1.500 38.10	1.5/8-18 UNEF

## Amphenol 62IN Series

### Straight Plug

#### 62IN 16

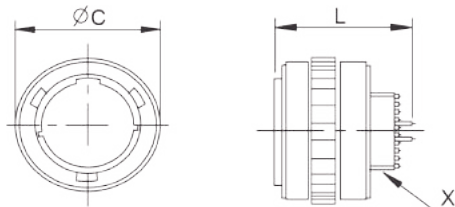

Shell Size	C Dia	L	X in Inches
8	19.05	24.79	7/16-28 UNEF
10	21.82	24.79	9/16-24 NEF
12	26.19	24.79	11/16-24 NEF
14	29.36	24.79	13/16-20 UNEF
16	32.54	24.79	15/16-20 UNEF
18	35.33	24.79	11/16-18 NEF
20	38.89	26.79	1 3/16-18 NEF
22	42.06	26.79	1 5/16-18 NEF
24	45.14	26.79	1 7/16-18 NEF

\*Without Termination Assemblies.

#### 62IN 16

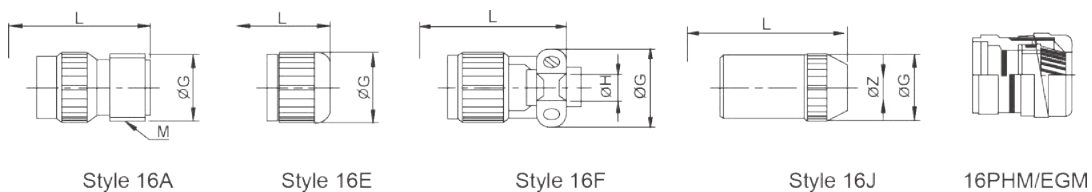

Style 16A

Style 16E

Style 16F

Style 16J

16PHM/EGM

Shell Size	Style 16A			Style 16E		Style 16F			Style 16J			
	G Dia	L	M Thread in Inches	G Dia	L	G Dia	H Dia	L	G Dia	L	For Cable Size Z Dia	
											Min	Max
8	14.25	41.00	1/2-28 UNEF	14.25	32.54	21.03	3.96	44.50	14.25	46.64	4.28	5.84
10	17.43	41.00	5/8-24 NEF	17.43	32.54	22.63	4.78	44.50	17.43	46.64	5.21	7.93
12	20.60	41.00	3/4-20 UNEF	20.60	32.54	25.81	7.93	44.50	20.60	49.20	8.59	11.23
14	23.78	41.00	7/8-20 UNEF	23.78	32.54	28.97	9.53	43.84	23.78	54.28	10.57	13.69
16	26.95	41.00	1-20 UNEF	26.95	32.54	30.56	12.70	47.40	26.95	59.36	13.97	15.65
18	30.13	41.00	1 3/16-18 NEF	30.13	32.54	36.22	15.88	47.40	30.13	64.45	15.24	17.07
20	33.30	41.00	1 3/16-18 NEF	33.30	32.54	36.22	15.88	51.81	33.30	70.05	16.13	18.98
22	36.75	41.00	1 7/16-18 NEF	36.75	32.54	39.80	19.05	51.81	36.75	75.13	17.02	21.49
24	39.61	42.11	1 7/16-18 NEF	39.61	32.54	44.07	20.32	55.32	39.61	76.25	18.80	22.71

\*Without Termination Assemblies.

## Amphenol 62IN Series

### 62IN Series BK4S Backshell Drawing

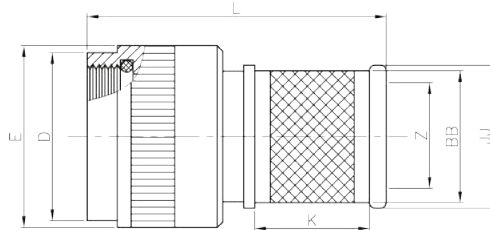

Shell Size Designator	ØD Max.		ØE Max.		ØZ Cable		ØBB Max.		ØJJ Max.		K Max.		L Max.	
	INCH	MM	INCH	MM	INCH	MM	INCH	MM	INCH	MM	INCH	MM	INCH	MM
8	0.615	15.60	0.738	18.75	0.281	7.2	0.391	9.9	0.486	12.3	0.433	11.0	1.970	50.0
10	0.748	19.00	0.838	21.30	0.338	8.6	0.493	12.5	0.587	14.9	0.433	11.0	2.090	53.1
12	0.856	21.75	0.988	25.10	0.506	12.9	0.665	16.9	0.783	19.9	0.476	12.1	2.100	53.3
14	0.982	24.95	1.074	27.30	0.562	14.3	0.744	18.9	0.862	21.9	0.476	12.1	2.100	56.1
16	1.102	28.00	1.250	31.75	0.619	15.7	0.821	20.9	0.939	23.9	0.476	12.1	2.280	57.9
18	1.220	30.99	1.387	35.25	0.675	17.1	0.891	22.6	1.010	25.6	0.476	12.1	2.360	59.9
20	1.345	34.17	1.488	37.80	0.731	18.6	0.954	24.2	1.072	27.2	0.476	12.1	2.400	61.0
22	1.470	37.34	1.837	41.60	0.843	21.4	1.095	27.8	1.213	30.8	0.476	12.1	2.520	64.0
24	1.591	40.42	1.738	44.15	0.900	22.86	1.160	29.4	1.276	32.4	0.476	12.1	2.520	64.0

## Amphenol 62IN Series

### Strain Relief Clamp With Grommet

**62IN-585-XX-XXS or XXP**  
(Replace XX-XX with the required insert arrangement)

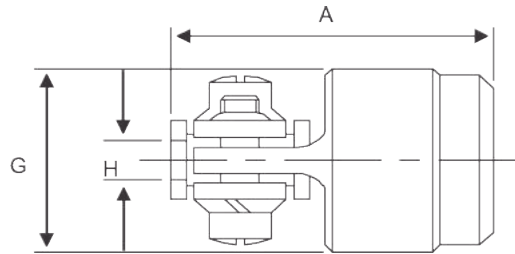

Shell Size	A Max.	G Max.	H Max.
8	25.17	21.03	4.09
10	25.17	22.63	4.90
12	25.17	25.81	8.05
14	24.51	28.98	9.65
16	28.07	30.56	12.83
18	28.07	36.22	16.00
20	32.64	36.22	16.00
22	32.64	39.80	19.18
24	34.88	44.07	20.45

All dimension in mm.

### Shell to Accept Conduit

**62IN-776-XX**  
(Replace XX with the required shell size)

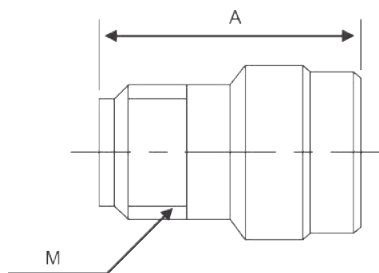

Shell Size	A Max.	H Thread in Inches
8	23.80	1/2-28 UNEF
10	23.80	5/8-24 NEF
12	23.80	3/4-20 UNEF
14	23.80	7/8-20 UNEF
16	23.80	1-20 UNEF
18	23.80	1 3/16-18 NEF
20	23.80	1 3/16-18 NEF
22	23.80	1 7/16-18 NEF
24	23.80	1 7/16-18 NEF

All dimension in mm.

## Amphenol 62IN Series

### SQ Adaptors

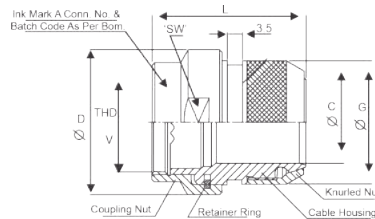

Size	V' THD, UNEF - 2B	Ø C Min.	Ø D Max.	Ø G +0.5 -0.0	L Max.	SW -0.2	Recommended Torque's (Nm)
8	7/16-28	6.5	20	16	36	18	4 +0.50
10	9/16-24	9.2	23	18	36	21	6 +0.50
12	11/16-24	12.2	27	22	36	24	8 ±1.0
14	13/16-20	15.2	30	25	37	28	10 ±1.0
16	15/16-20	18.3	33	28	37	31	
18	1 1/16-18	20.0	36	32	37	34	13 ±1.0
20	1 3/16-18	23.0	40	34	37	37	
22	1 5/16-18	26.0	43	38	37	41	
24	1 7/16-18	28.8	46	41	37	44	

All dimension in mm.

## Shrink Boot Adaptors

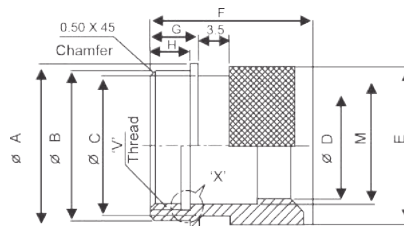

Size	Ø 'A' -0.3	Ø 'B'	Ø 'C' -0.2	Ø 'D' +0.2	Ø 'E' +0.5	'F'	'G'	'H'	V' Thread UNEF -2B	'M' +0.1	
8	15.4	14.0	13.1	9.2	15.1	17.5	5.50	4.50	7/16-28	10.2	
10	18.5	17.0	15.9	12.1	17.9				9/16-24	13.3	
12	21.8	20.3	21.2	15.1	23.2				11/16-24	16.5	
14	25.0	23.3	22.1	18.4	24.0				13/16-20	19.5	
16	28.2	26.4	26.0	21.6	29.3				20.0	15/16-20	22.6
18	31.3	29.5	28.4	24.1	31.5				20.0	1 1/16-18	25.6
20	34.5	32.7	32.3	27.3	35.6				21.3	1 3/16-18	28.8
22	37.7	35.8	34.7	30.5	38.0				21.3	1 5/16-18	32.0
24	40.9	39.0	37.9	33.7	41.0	20.0	5.00	4.00	1 7/16-18	35.2	

All dimension in mm.



## Amphenol 62IN Series PG Adaptors with 'O' Ring

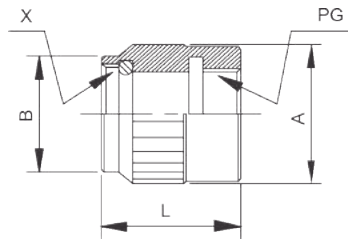

Part Number	For Shell Size	X Thread in Inches	A	B	L	PG Thread
62IN08-PG7	8	7/16-28 UNEF	16.50	14.50	20.00	PG7
62IN10-PG9	10	9/16-24 NEF	22.00	17.70	20.00	PG9
62IN12-PG9	12	11/16-24 NEF	22.00	21.00	20.00	PG9
62IN14-PG13.5	14	13/16-20 UNEF	28.00	23.50	25.00	PG13.5
62IN16-PG9	16	15/16-20 UNEF	29.00	27.80	30.00	PG9
62IN18-PG16	18	1/16-18 NEF	31.50	31.00	35.00	PG16
62IN20-PG21	20	13/16-18 NEF	35.00	34.00	40.00	PG21
62IN24-PG16	24	17/16-18 NEF	41.50	40.50	40.00	PG16

All dimension in mm.

## Amphenol 62IN Series EGM/PHM Adaptor

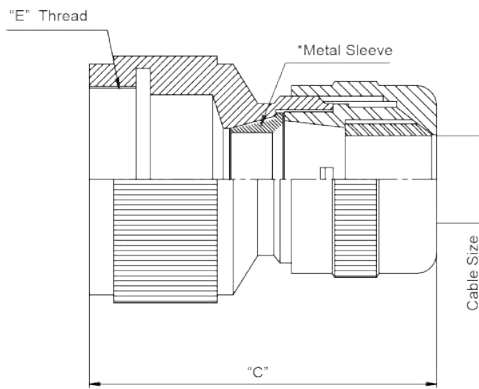

\*EGM - Supplied with metal sleeve for shielded cable  
 \*PHM - Supplied without metal sleeve for unshielded cable

Shell Size	"C" Ref.	PG Size (Cable Size in MM)	"E" Thread for Straight
8	30.00	PG 11 (4 to 10)	7/16" -28 UNEF
10		PG 11 (4 to 10)	9/16" -24 NEF
12		PG 11 (4 to 10)	11/16" -24 NEF
14		PG 21 (11 to 18)	13/16" -20 UNEF
16		PG 21 (11 to 18)	15/16" -20 UNEF
18		PG 21 (11 to 18)	1 1/16" -20 UNEF
20	35.00	PG 21 (11 to 18)	1 3/16" -18 UNEF
22		PG 21 (11 to 18)	1 5/16" -18 NEF
24		PG 21 (11 to 18)	1 7/16" -18 UNEF

\*EGM/PHM11 can accept cable Min. 5.70 mm & Max. 10.85 mm  
 \*EGM/PHM21 can accept cable Min. 12.70 mm & Max. 17.85 mm

## Amphenol 62IN Series

### Shrink Boot Adaptor

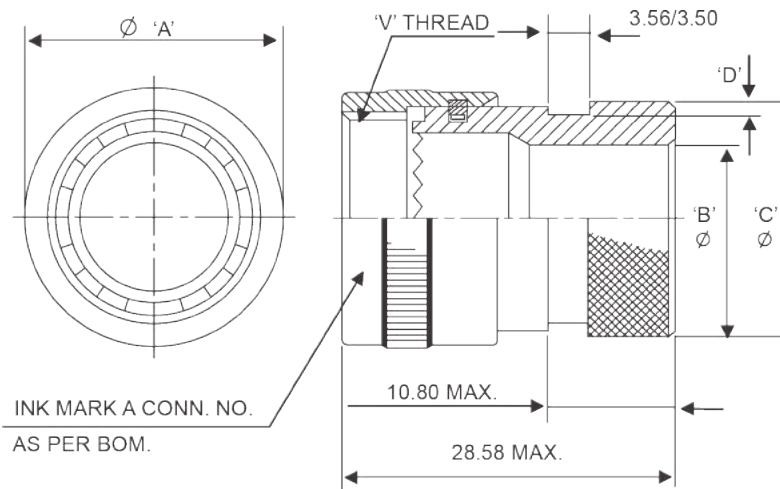

Shell Size	ØA Max.	ØB Max.	ØC Max. +0.0 -0.51	D + 0.20 -0.0	V' Thread UNEF-2B
8	15.67	6.35	13.54	1.12	7/16" -28
10	18.64	9.02	15.37		9/16" -24
12	21.79	12.74	19.66		11/16" -24
14	24.99	14.35	21.29		13/16" -20
16	28.24	17.53	24.46		15/16" -20
18	30.94	19.53	26.47		11/16" -18
20	34.16	22.71	30.91	1.75	13/16" -18
22	32.79	25.88	34.42		15/16" -18
24	40.46	28.80	36.65		17/16" -18

## Amphenol 62IN Series

### Right Angle Backshell

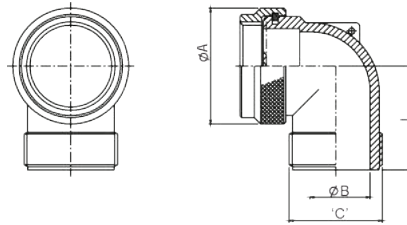

Shell Size	DRG No.	ØA Max.	ØB ±0.13	'C' -2A Thread.	L Max.
8	500238-8	18.85	7.30	9/16"-24 NEF	20.80
10	500238-10	21.70	10.18	5/8"-24 UNEF	21.70
12	500238-12	24.60	13.35	3/4"-20 UNEF	23.35
14	500238-14	27.85	16.26	7/8"-20 UNEF	24.85
16	500238-16	31.2	19.40	1" -20 UNEF	26.45
18	500238-18	34.15	22.00	1 3/16"-18 UNEF	28.70
20	500238-20	37.25	24.20		29.60
22	500238-22	40.65	28.50	1 7/16"-18 NEF	31.60
24	500238-24	44.00	31.65		33.60

All dimension in mm.

### JC Clamp Backshell

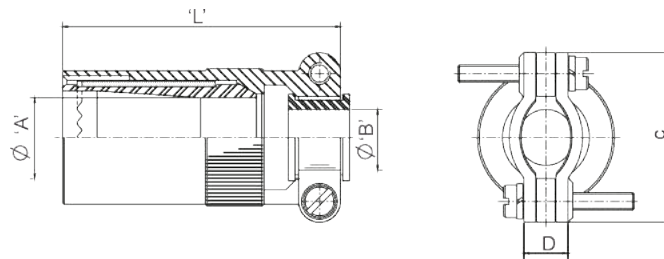

Shell Size	A		B	C	D Max Closed	L' Max.
	Min.	Max.	±0.13	Max.		
8	4.28	5.84	3.96	21.03	4.75	40.50
10	5.21	7.93	4.78	22.63		
12	8.59	11.23	7.93	25.81	7.14	
14	10.57	13.69	9.58	28.97	8.26	48.00
16	13.97	15.65	12.70	30.56	9.04	54.50
18	15.24	17.07	15.88	36.22	11.58	59.00
20	16.13	18.98	15.88	36.22	13.18	67.00
22	17.02	21.49	19.05	39.80		73.40
24	18.80	22.71	20.32	44.07	16.69	77.00

All dimension in mm.

## Amphenol 62IN Series

### Metallic Dust Covers

#### For Receptacles

Dust Cover Style		To Fit Receptacle Style
With Chain	With Nylon Cord	
62IN-736	68IN-813	Jam Nut
62IN-737	62IN-814	Cable Mounting
62IN-738	62IN-812	Wall and Box Mounting

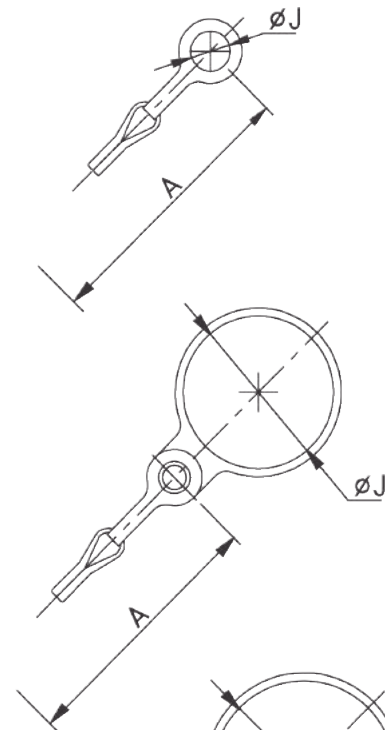
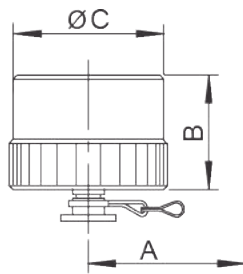

#### For Plugs

Dust Cover Style	
With	With Nylon Cord
62IN-742	62IN-810

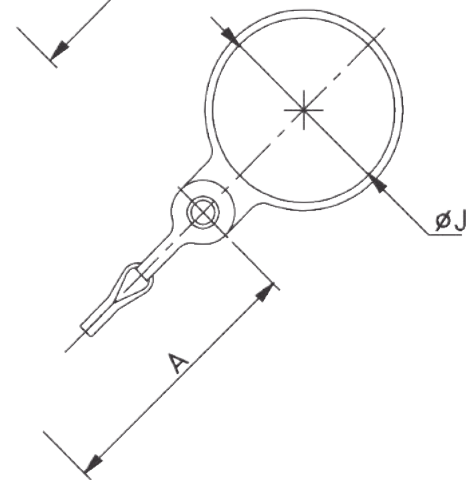
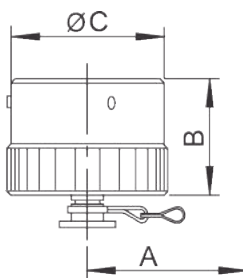

Shell Size	A Chain / Cord Length	B		C Dia	J Dia			
		For Receptacles	For Plugs		736 813	737 814	738 812 742 810	738 812 742 810
8	76.20	15.21	15.03	18.64	14.68	11.63	4.40	
10	76.20	15.21	15.03	21.82	17.86	14.81	4.40	
12	88.90	15.21	15.03	25.40	22.63	17.98	4.40	
14	88.90	15.21	15.03	28.57	25.81	22.76	4.40	
16	88.90	15.21	15.03	31.75	29.39	25.93	4.40	
18	88.90	15.21	15.03	34.92	32.16	29.11	4.40	
20	101.60	15.21	15.03	38.10	35.33	32.28	4.40	
22	101.60	15.21	15.03	41.27	38.51	35.46	4.40	
24	101.60	15.21	15.03	44.45	41.68	38.63	4.40	

## Amphenol 62IN Series

### Accessories

XX: Put Shell

62IN-760-XX

(Replace XX with the required shell size)

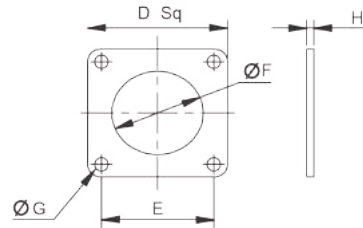
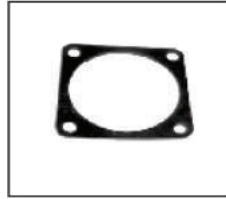

Shell Size	D	E	F Dia	G Dia	H Max
8	20.62	15.08	12.90	3.30	1.06
10	23.82	18.26	16.07	3.30	1.06
12	26.18	20.65	19.25	3.30	1.06
14	28.57	23.01	22.42	3.30	1.06
16	30.96	24.61	25.60	3.30	1.06
18	33.32	27.00	28.77	3.30	1.06
20	36.52	29.36	31.95	3.30	1.06
22	39.70	31.75	35.13	3.30	1.06
24	42.87	34.92	38.30	3.96	1.06

## Amphenol 62IN Series

### Insert Arrangements

Front face of pin insert or rear of socket insert illustrated

Contact Legend		
Symbol	●	○
Contact size	16	20

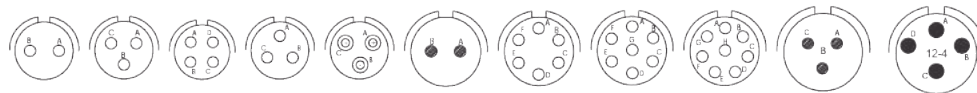

Insert arrangement	8-2	8-3	8-4	8-33	8-98	10-2	10-6	10-7	10-8	12-3	12-4
Service rating	I	I	I	I	I	II	I	I	I	II	II
Number of contacts	2	3	4	3	3	2	6	7	8	3	4
Contact size	20	20	20	20	20	16	20	20	20	16	16

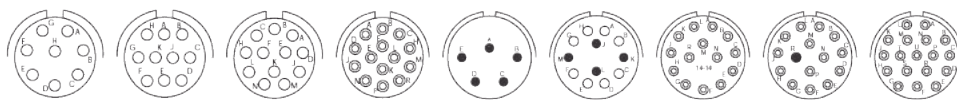

Insert arrangement	12-8	12-10	12-12	12-14	14-5	14-12	14-14	14-15	14-18
Service rating	I	I	I	I	II	I	I	I	I
Number of contacts	8	10	12	14	5	4 8	14	1 14	18
Contact size	20	20	20	20	16	16 20	20	16 20	20

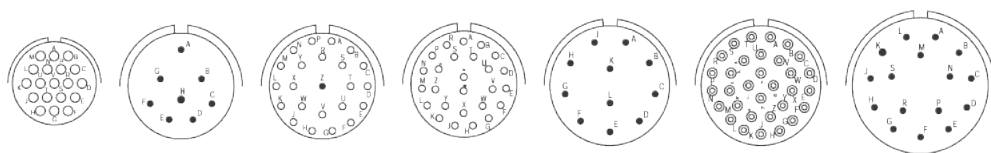

Insert arrangement	14-19	16-8	16-23	16-26	18-11	18-32	20-16
Service rating	I	II	I	I	II	I	II
Number of contacts	19	8	1 22	26	11	32	16
Contact size	20	16	16 20	20	16	20	16

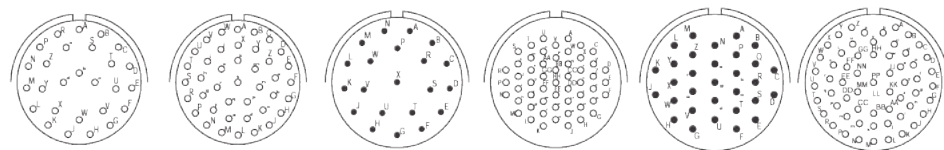

Insert arrangement	20-27	20-41	22-21	22-55	24-31	24-61
Service rating	I	I	II	I	I	I
Number of contacts	27	41	21	55	31	61
Contact size	20	20	16	20	16	20



**MATEC Electronics** is an authorized and leading distributor, that specializes on the design and custom-engineered connectors, cables and electronic interconnect solutions for Military-Aerospace, Industry and Telecom market fields. MATEC's deep technical and commercial knowledge on it's concentrated product portfolio has made the company the chosen distributor of the customers in the region it serves Turkey, Middle East, Africa, Eastern Europe. MATEC Electronics mainly distributes world's leading interconnect manufacturer, Amphenol. The company provides not only sales channel for Amphenol, but also give services to it's valuable customers with highly experienced field application engineers and inside customer services.

**Add to the large product portfolio of Amphenol, MATEC Electronics also represents Reflex Photonics, Energy Power and Bufab.**

#### Head Office

Ahi Evran Cad. No: 21  
Kat: 4 Daire: 24  
Polaris Plaza Maslak,  
Sariyer, ISTANBUL

#### Branch Office

Bestepe Mah.  
Nergis Sok. Via Flat  
Kat: 3 No: 7/2  
Sogutozu, ANKARA

#### Warehouse

Tatlisu Mah.  
Ersoy Sok.  
No: 3  
Umraniye, ISTANBUL

[www.matec.com.tr](http://www.matec.com.tr)  
[info@matec.com.tr](mailto:info@matec.com.tr)  
+90 216 365 80 10